

IPURI





KAJA IPURI Single-lever basin mixer DN15 with pop-up waste

flow rate A
output 13 l/min
at 3 bar flow pressure

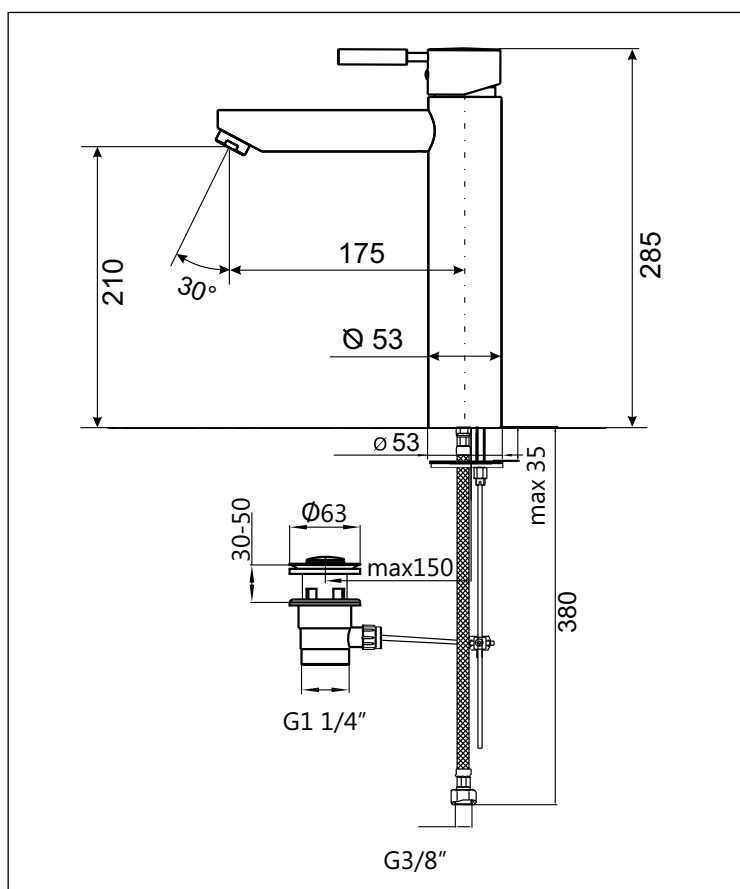
extension 175 mm
with pop-up waste, aerator M24x1,
flexible connection hoses,
ECO mixing cartridge with SiC-/ceramic-disks
and adjustable temperature limiter



finish	 code with stick lever	 code with ring lever
chrome	55045-C	52045-C
different product options (see following pages)		
without pop-up waste		

IPURI





KAJA IPURI Single-lever basin mixer DN15

flow rate A
output 13 l/min
at 3 bar flow pressure

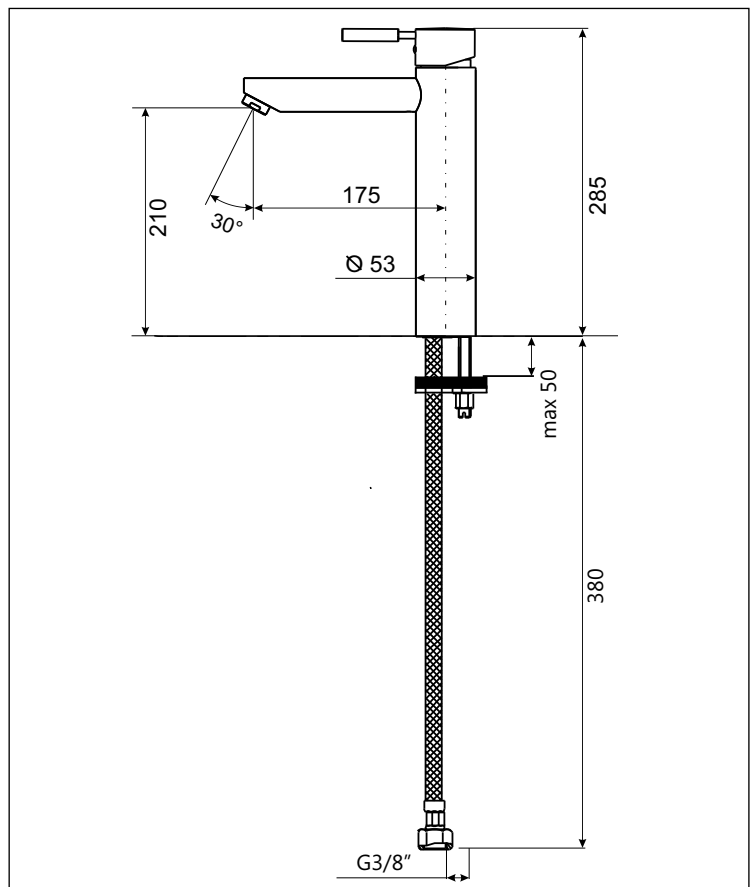
without pop-up waste,
extension 175 mm,
aerator M24x1,
flexible connection hoses,
ECO mixing cartridge with SiC-/ceramic-disks
and adjustable temperature limiter



finish	 code with stick lever	 code with ring lever
chrome	55055-C	52055-C